

ISTRUZIONI DI MONTAGGIO
ASSEMBLY INSTRUCTIONS



ART. 90992



Dimensioni generali / General dimensions

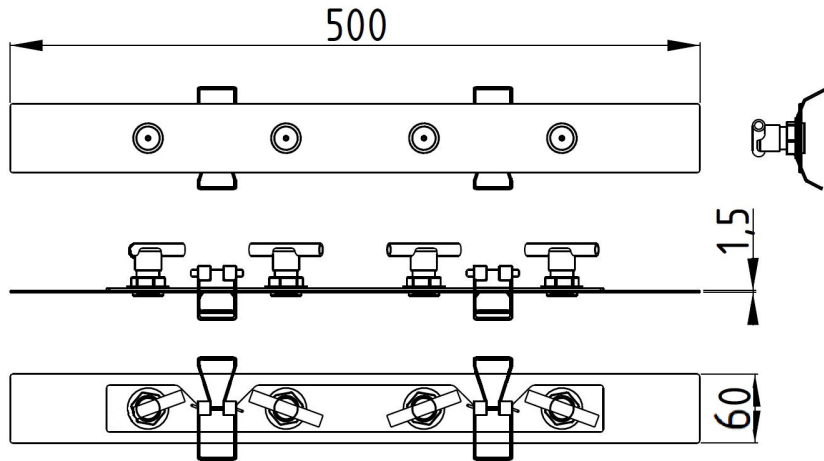

MAX 70°C
BEST 38/40°C



MIN 1 Bar
MAX 5 Bar
BEST 3 Bar

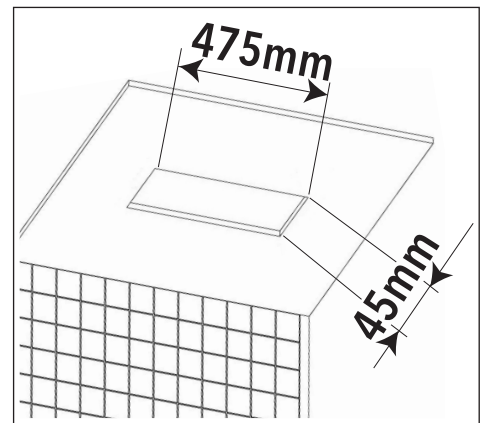

Taglio sede controsoffitto
False ceiling cut

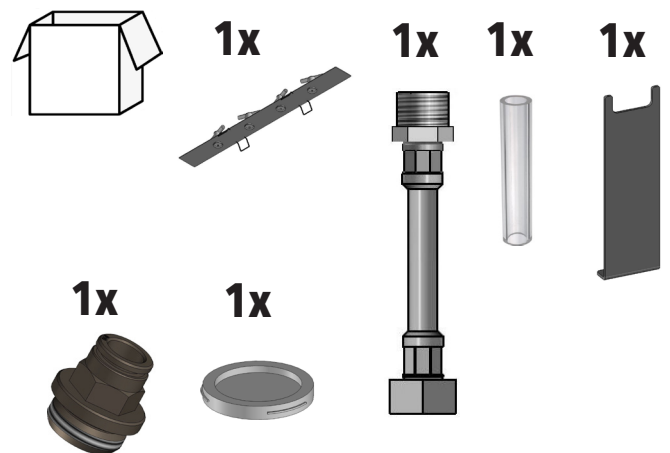
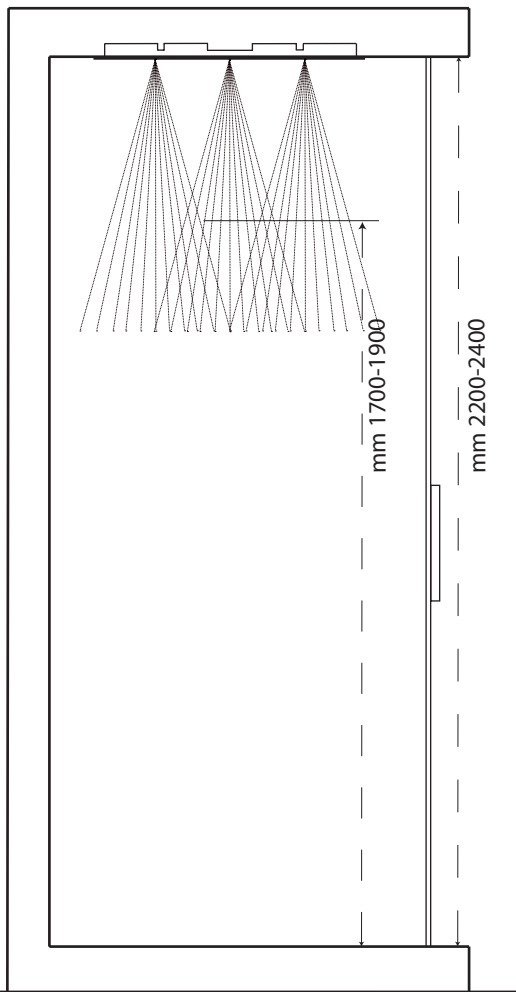

L'apparecchio deve essere installato da personale abilitato ai sensi e per l'effetto delle leggi in vigore.
According to the law, all installation and maintenance operations require a qualified person.

1

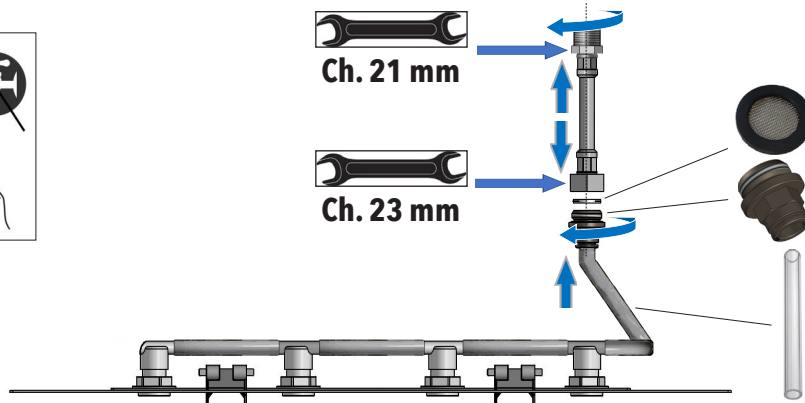
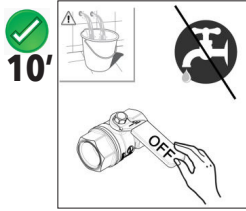

2

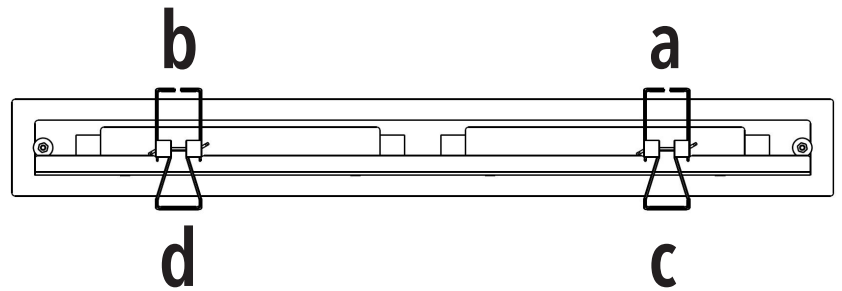
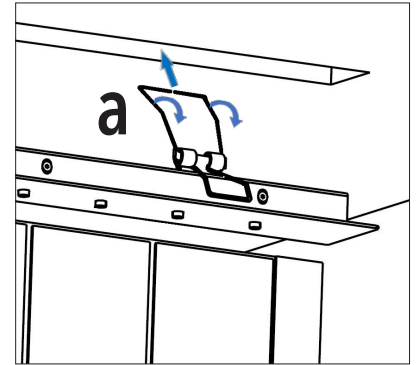
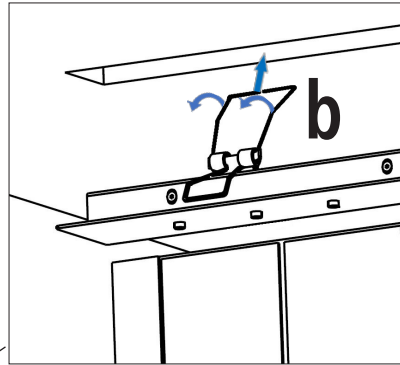
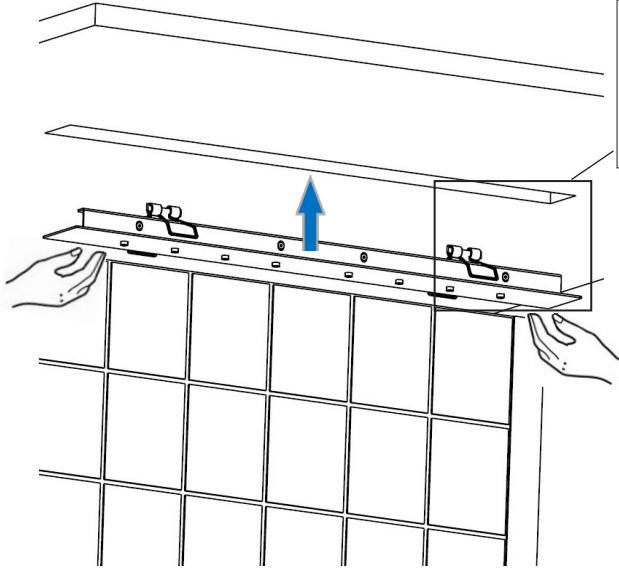

3

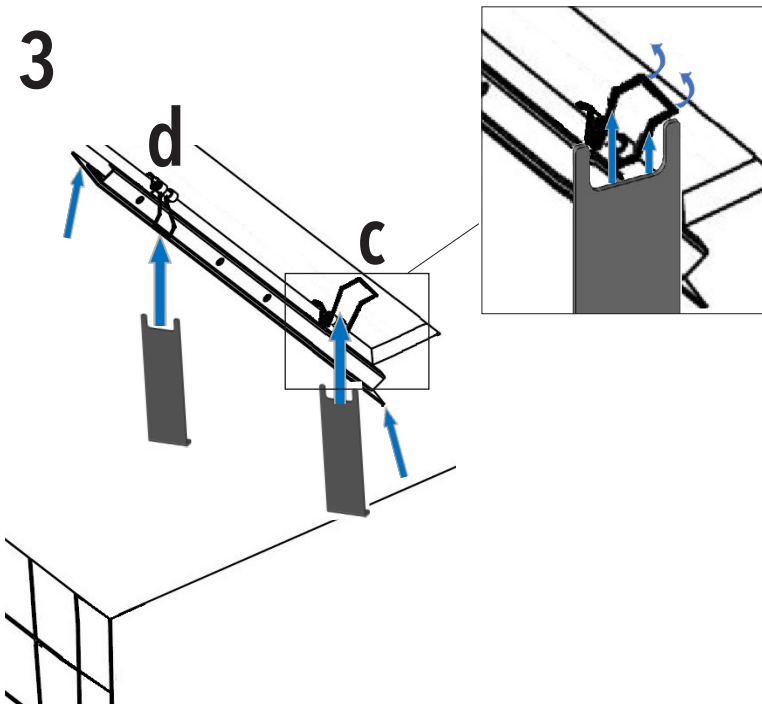

4

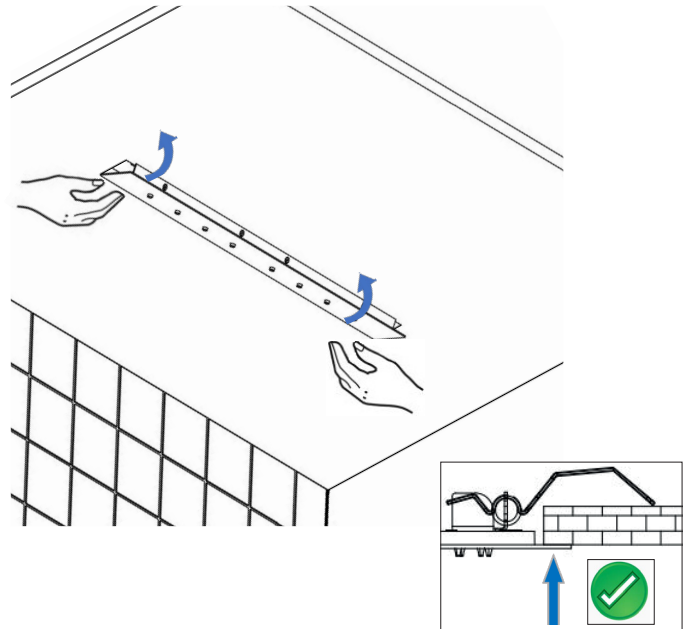

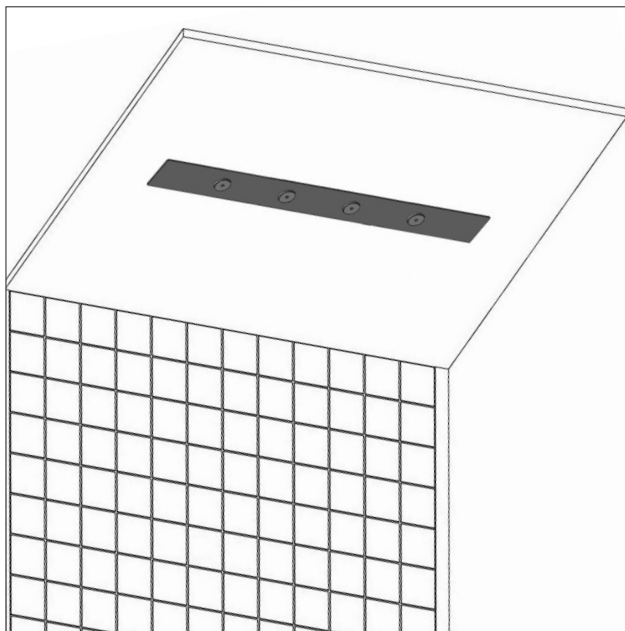

NOT COVERED BY PRODUCT CARE

Not correct use.
Incorrect setup of the hydraulic system.
Water impurities or limeston.
Not suitable detergents.

LA GARANZIA DEL PRODOTTO NON COPRE

L'utilizzo improprio.
L'errata predisposizione dell'impianto idraulico.
Danni causati da depositi di calcare o altre impurità.
Detergenti non adatti.



TWO-YEAR PRODUCT CARE

Against defects or defects of fabrication.

DUE ANNI DI GARANZIA DEL PRODOTTO

Contro i difetti o vizi di fabbricazione.

ATTENZIONE: Si declina ogni responsabilità relativa ad eventuali inesattezze contenute in queste istruzioni dovute ad errori di trascrizione.

WARNING: We decline all responsibility and eventual inaccuracy contained in the instructions due to transcript errors.