



R U B I N E T T E R I E

**F.lli Frattini®**

**ISTRUZIONI DI INSTALLAZIONE INCASSO DOCCIA UNIVERSALE**  
**INSTALLATION INSTRUCTIONS FOR UNIVERSAL BUILT-IN SHOWER MIXER**  
**INSTALLATIONSANWEISUNGEN FÜR UNIVERSAL UP-BRAUSEMISCHER**



**CONSERVARE CON CURA. DA CONSEGNARE ALL'UTILIZZATORE FINALE**  
**KEEP WITH CARE. TO BE GIVEN TO THE END USER**  
**HALTEN MIT SORGFALT. WERDEN AN DEN ENDVERBRAUCHER GEGEBEN**

**INDICE**  
**INDEX**  
**INHALTSVERZEICHNIS**

---

■ SPECIFICHE TECNICHE DI FUNZIONAMENTO Operating technical specifications Betriebsanleitungen	pag.2
■ SCHEMA TECNICO DI ENTRATE E USCITE - PROVA IMPIANTO Technical scheme of inlets and outlets - water system test Technischer Plan des Eingans und Ausgangs - Prüfung der Wasseranlage	pag.3
■ INSTALLAZIONE Installation Installation	pag.4-5-6
■ UNIVERSAL BOX Possibili kit esterni External kit Endmontage Set	pag.7
■ RACCOMANDAZIONE PER LA PULIZIA DEI PRODOTTI Cleaning recommendation Reinigungsempfehlung	pag.8

# SPECIFICHE TECNICHE DI FUNZIONAMENTO

## Operating technical specifications

### Betriebsanleitungen

#### **IT** Dati tecnici, consigli di manutenzione e pulizia.

- Pressione minima:  
0.05 MPa (0.5 bar)
- Pressione massima:  
1.00 MPa (10 bar)

Tuttavia per avere la massima resa in termini di durata e manovrabilità è consigliabile che la pressione abbia i seguenti valori:

- Pressione minima:  
0.1 MPa (1 bar)
- Pressione massima:  
0.5 MPa (5 bar)

In caso la pressione superi i 0.6 Mpa si consiglia di installare un riduttore di pressione. Sono inoltre da evitare forti differenze della stessa tra l'alimentazione dell'acqua calda e fredda. Prima di procedere all'installazione del rubinetto è necessario pulire le tubature per eliminare eventuali detriti inoltre è consigliabile, a monte della rubinetteria, installare dei rubinetti d'arresto con filtro. I nostri prodotti non necessitano di manutenzione, fatta eccezione della pulizia periodica dell'aeratore.

#### **EN** Technical details, maintenance and clean advices

- Minimal pressures:  
0.05 MPa (0.5 bar)
- Maximum pressures:  
1.00 MPa (10 bar)

The way to obtain the maximal performance in duration and **manoeuverability** it is suggested that the pression of the water stay as following:

- Minimal pressures:  
0.1 MPa (1 bar)
- Maximum pressures:  
0.5 MPa (5 bar)

In case that the pressure exceeds 0.6 Mpa it is suggested to install

a **pressure reducer**, and strong pressure differences between the inlet of the warm and cold water have to be avoid. Before proceeding the installation of the mixer it is necessary to clean the piping in way to eliminated eventual silts, moreover it is suggested to install stop cocks with filter. Our products do not require service or maintenance, with the exception of the periodical cleaning of the aerator.

#### **DE** Technische Daten, Empfehlungen zur Instandhaltung und Reinigung

- Mindestdruck:  
0.05 MPa (0.5 bar)
- Höchstdruck:  
1.00 MPa (10 bar)

Der Druck sollte sich innerhalb folgender Werte befinden, damit ein Höchstmaß an Lebensdauer und Handlichkeit gewährleistet ist:

- Mindestdruck:  
0.1 MPa (1 bar)
- Höchstdruck:  
0.5 MPa (5 bar)

Sollte der Druck 0,6 MPa (6 bar) übersteigen, ist der Einbau eines **Druckminderventils** angebracht. Darüber hinaus sind bei der Warm und Kaltwasserversorgung starke Druckunterschiede zu reinigen, um eventuelle Schmutzablagerungen zu entfernen. Es ist außerdem empfehlenswert, vor der Armatür Absperrventile mit Filter einzubauen. Unsere Produkte sind mit Ausnahme des Luftsprudlers wartungsfrei.

## SCHEMA TECNICO DI ENTRATE E USCITE - PROVA IMPIANTO

Technical scheme of inlets and outlets - water system test  
Technischer Plan des Eingans und Ausgans - Prüfung der Wasseranlage

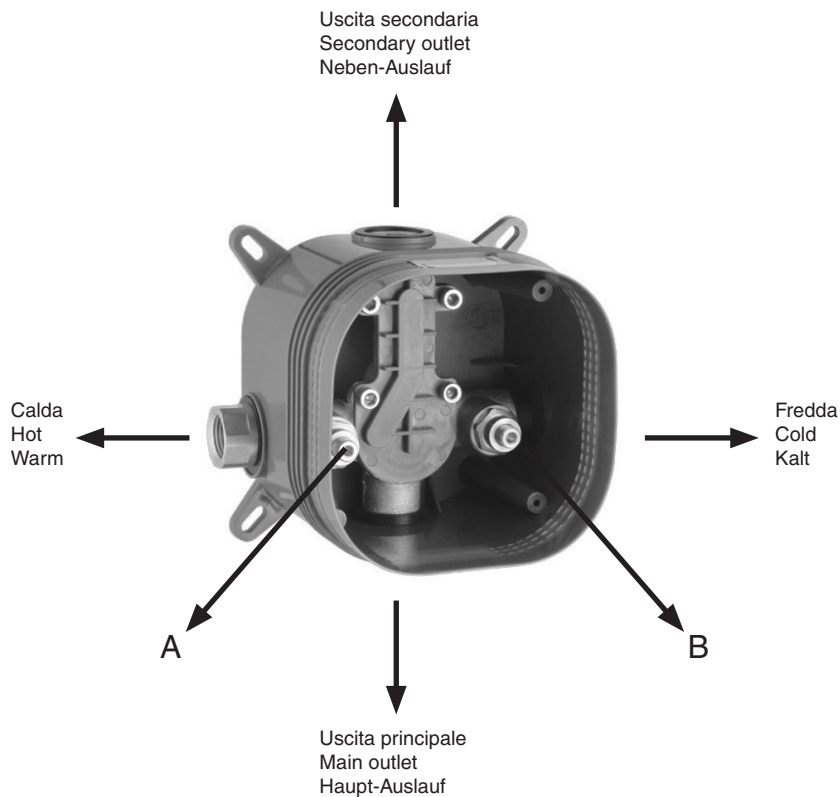

---

### NB

**Per un eventuale test dell'impianto chiudere le valvole (A) e (B).**

**To test the hydraulic plant close the valves (A) and (B)**

**Um den Wasseranlage zu testen die Ventile A und B schließen.**

---

# INSTALLAZIONE

## Installation - Installation

Monocomando  
incasso 1 via  
Single lever  
concealed mixer  
1 Outlet  
Einhebel  
1-weg



Monocomando  
incasso 2 vie  
Single lever  
concealed mixer  
2 Outlet  
Einhebel  
2-wege



1. Installare Universal Box
2. Scegliere se monocomando o termostatico
1. Install the Universal Box
2. Choose single lever mixer or thermostatic mixer
1. Den Up-Box einstellen
2. Den Einhebel oder Thermostat wählen



Miscelatore incasso  
termostatico 2 vie  
Thermostatic concealed  
mixer maximum 2 Outlets  
Thermostat 2 weg, wege



# INSTALLAZIONE

## Installation - Installation

Monocomando  
incasso  
Single lever  
concealed mixer  
Einhebel Up-Mischer

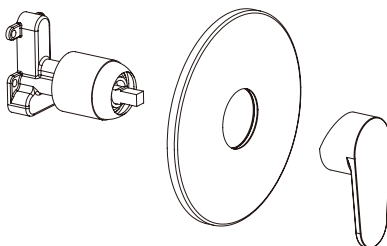

- 1 VIA  
- 1 OUTLET  
- 1 WEG

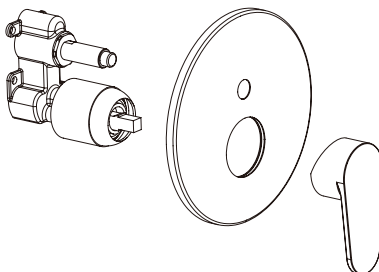

- 2 VIE  
- 2 OUTLETS  
- 2 WEGE



Miscelatore incasso  
termostatico  
Thermostatic  
concealed mixer  
maximum  
2 Outlets  
Thermostat 2 wege  
(max)

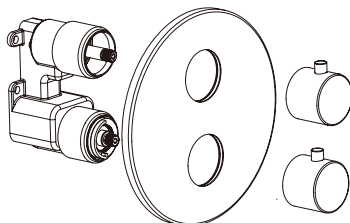

- 2 VIE  
- 2 OUTLETS  
- 2 WEGE

# INSTALLAZIONE

Installation - Installation

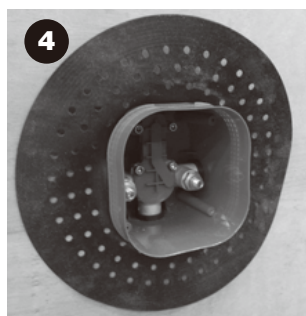
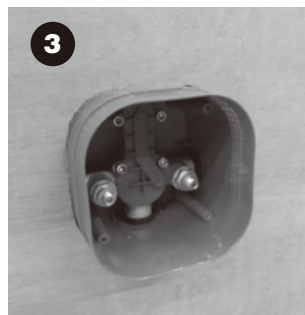
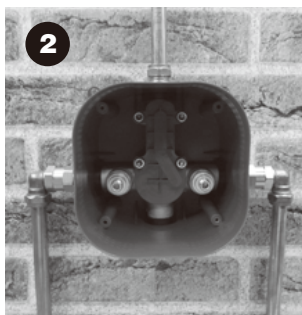

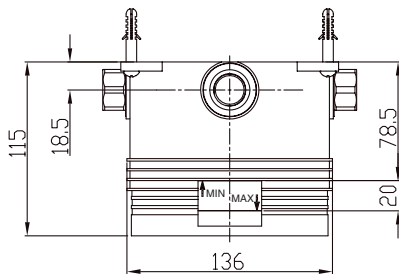
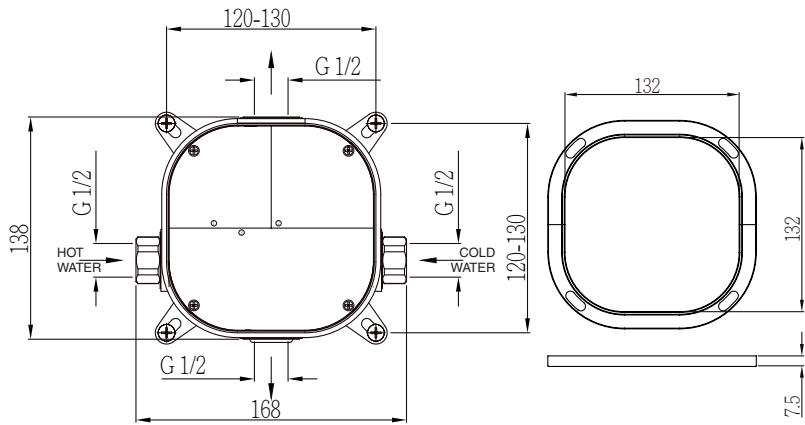
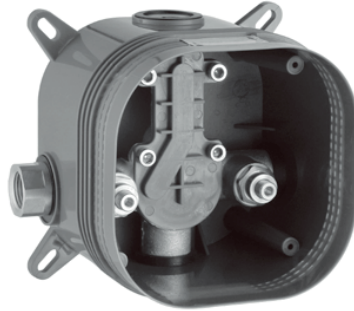



## UNIVERSAL BOX

Kit esterni  
External kit  
Endmontage Set



art. 98334



art. R24362



art. R24363



art. R24364



art. R24365



art. R24351

## RACCOMANDAZIONE PER LA PULIZIA DEI PRODOTTI

Cleaning products recommendation

Reinigungsempfehlung für Produkte

**IT** Oggi la rubinetteria moderna dei sanitari, della cucina e delle docce, è prodotta con materiali, molto differenti per soddisfare la richiesta del mercato al design ed alla funzionalità.

Per evitare danni e reclami si devono considerare alcuni criteri durante l'uso e la successiva pulizia.

Nella cura della rubinetteria e delle docce si devono osservare le seguenti indicazioni:

Utilizzare soltanto i prodotti di pulizia che sono destinati per il tipo di pulizia richiesta.

Non utilizzare prodotti che contengono acido cloridrico, acido formico, candeggina oppure acido acetico, poiché questi possono causare gravi danni.

Non utilizzare detergenti contenenti acido fosforico dove non indicato.

Non utilizzare mai miscele di diversi detergenti.

Non utilizzare attrezzi per pulizia abrasivi inadatti, come abrasivi, spugne e panni in microfibra.

Seguire sempre le istruzioni per l'uso dei produttori e dei mezzi di pulizia.

Evitare la formazione di depositi di calcare con pulizia periodica.

Non spruzzare mai il prodotto direttamente sulla rubinetteria, ma su un panno perché parte degli spruzzi possono infiltrarsi nelle aperture della rubinetteria e causare danni.

Dopo la pulizia sciacquare bene con acqua per eliminare definitivamente i residui dei prodotti di pulizia.

L'utilizzo di pulitori a vapore è vietato, poiché le temperature elevate possono danneggiare il prodotto.

Componenti con superfici danneggiate devono essere sostituiti, in caso contrario c'è il rischio di ferirsi.

Danni a causa di trattamenti impropri non sono coperti dalla nostra garanzia.

**EN** Modern sanitary tapware, kitchen mixers and showers consist of very different materials to comply with the needs of the market with regard to design and functionality.

To avoid damage and malfunction, it's necessary to consider certain criteria when cleaning.

At the cleaning of the fittings and showers, in principle, it must be point out:

Only use cleaning material witch is explicitly provided for this type of application.

Never use cleaning materials, which contain hydrochloric acid, formic acid, chlorine pale lye or acetic acid, as they cause considerable damage. Phosphorus acidic cleaners are only conditionally applicable.

Mixing cleaning agents is not permitted, generally.

Never use cleaning materials or appliances with an abrasive effect, such as unsuitable cleaning powders, sponge pads or micro fibre cloths.

The instructions of the cleaning agent manufacturers have be followed absolutely.

The building up of calcification has to be removed by cleaning regularly.

When using spray cleaners, spray first onto a soft cloth or sponge never directly onto the sanitary tapware, as drops could enter openings, gaps and cause damage.

After cleaning rinse thoroughly with clean water to remove any cleaner residue.

The use of steam cleaners isn't permitted. The high temperatures can damage the product.

Components with damages surfaces must be exchanged, otherwise this could cause injury.

Damage caused by improper treatment will not be covered by our guarantee.

**DE** Moderne Sanitär-, Küchenarmaturen und Brausen bestehen aus sehr unterschiedlichen Werkstoffen um den Marktbedürfnissen hinsichtlich Design und Funktionalität gerecht zu werden. Um Schäden und Reklamationen zu vermeiden, müssen sowohl bei der Benutzung als auch bei der anschließenden Reinigung bestimmte Kriterien berücksichtigt werden. Bei der Pflege der Armaturen und Brausen gilt grundsätzlich zu beachten:

Es dürfen nur Reinigungsmittel eingesetzt werden, die für diesen Anwendungsbereich ausdrücklich vorgesehen sind. Reiniger die Salzsäure, Ameisensäure, Chlorbleiche oder Essigsäure enthalten, dürfen nicht verwendet werden, da diese zu erheblichen Schäden führen können.

Schwefelsäurehaltige Reiniger sind nur bedingt anwendbar. Das Mischen von Reinigungsmitteln ist generell nicht zulässig. Abrasivwirkende Reinigungshilfsmittel und Geräte wie untaugliche Scheuermittel, Padschwämme und Mikrofasertücher dürfen ebenfalls nicht verwendet werden. Dem Aufbau von Verkalkungen ist durch regelmäßiges Reinigen vorzubeugen. Bei der Sprühreinigung die Reinigungslösung keinesfalls auf die Armaturen, sondern auf das Reinigungstuch geben und damit die Reinigung durchführen, da der Sprühnebel in Öffnungen und Spalten der Armaturen eindringen und Schäden verursachen kann. Nach der Reinigung muss ausreichend mit klarem Wasser nachgespült werden um verbliebene Reinigungsmittel restlos zu entfernen. Die Verwendung von Dampfreinigern ist nicht erlaubt, die hohen Temperaturen können die Produkte beschädigen. Bauteile mit beschädigten Oberflächen müssen ausgetauscht werden, ansonsten besteht Verletzungsgefahr. Schäden, die durch unsachgemäße Behandlung entstehen, unterliegen nicht unserer Gewährleistung.





RUBINETTERIE

**F.lli Frattini®**

Produttori di rubinetteria  
Made in Italy da oltre 50 anni

---

Via Roma, 125 - C.P. 107 - 28017 San Maurizio d'Opaglio (NO) . ITALY  
tel. 0322 96127-96128 - fax 0322 967272

[www.frattini.com](http://www.frattini.com)

[info@frattini.it](mailto:info@frattini.it) - [export@frattini.it](mailto:export@frattini.it)